

# Assembling your new Kranzle K145T

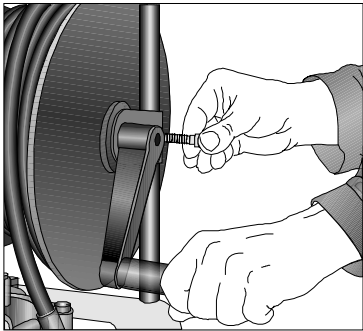

Put high pressure cleaner into upright position. Remove the screw from the brass element. Put the crank on the brass hexagon and fasten with the screw.

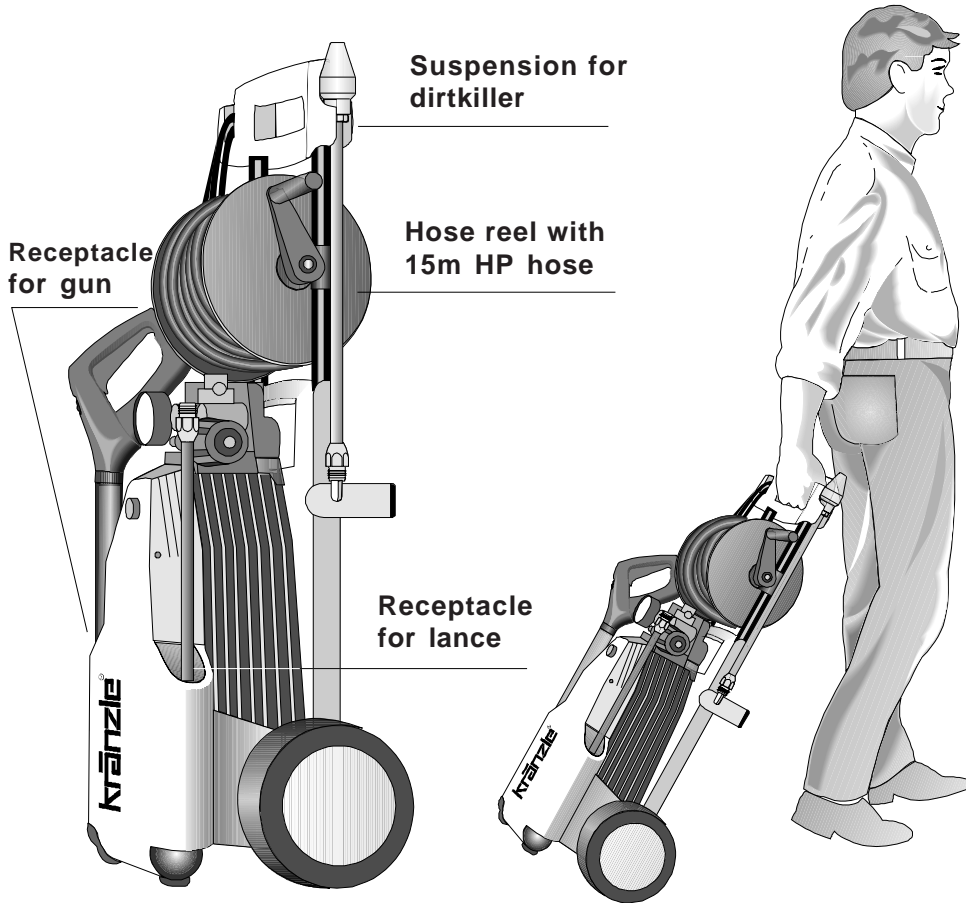

# Preparation for use

1. Put high pressure cleaner into

Check oil level DO NOT OVER FILL !

ONLY OPERATED  
IN HORIZONTAL  
POSITION !

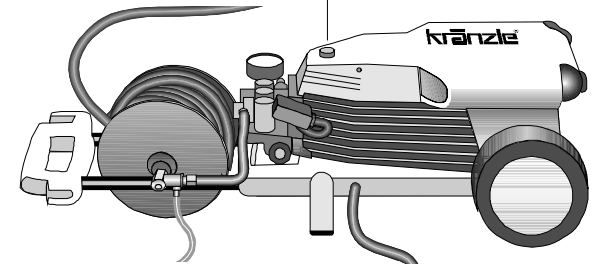

2. Connect the high pressure lance to the spray gun.

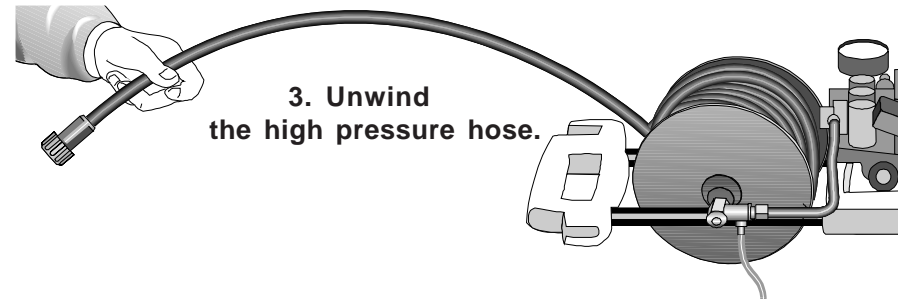
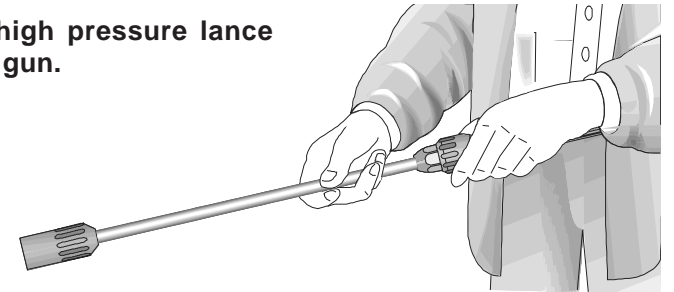

3. Unwind  
the high pressure hose.

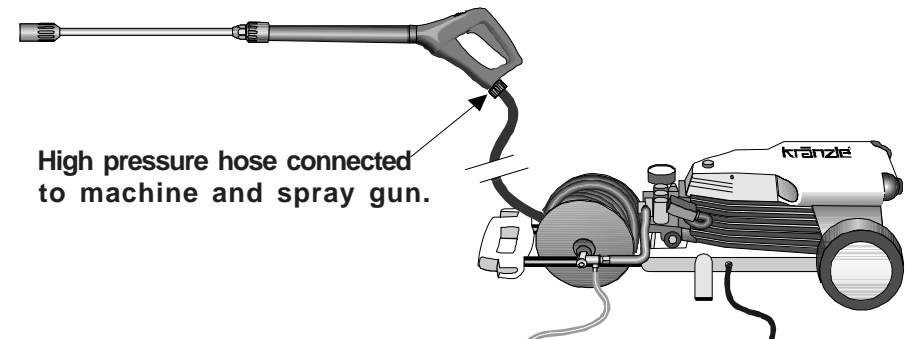

High pressure hose connected  
to machine and spray gun.

## Preparation for use

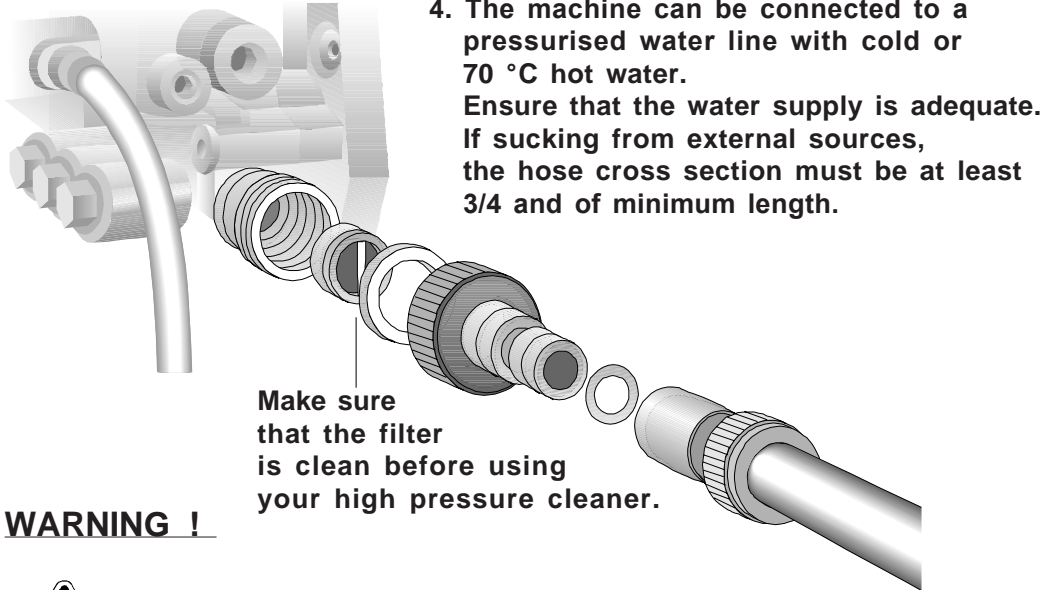

4. The machine can be connected to a pressurised water line with cold or 70 °C hot water. Ensure that the water supply is adequate. If sucking from external sources, the hose cross section must be at least 3/4 and of minimum length.

Make sure that the filter is clean before using your high pressure cleaner.

### WARNING !



When running your high pressure cleaner with hot water of 60 °C or 70 °C

DO NOT TOUCH THE PUMP WITHOUT SAFETY GLOVES!

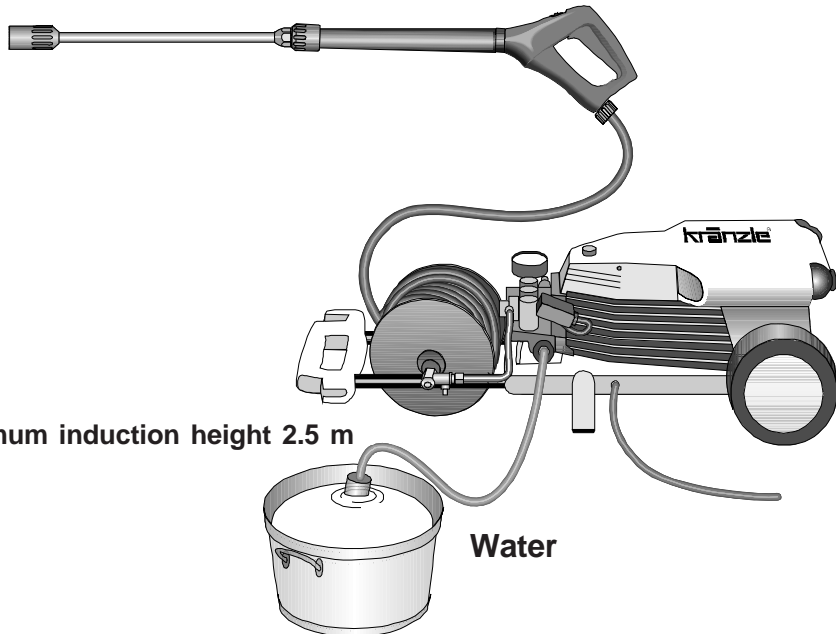

5. Maximum induction height 2.5 m

## Preparation for use

### Starting the machine

YOU MUST SQUEEZE THE TRIGGER GUN WHILE SWITCHING ON THE MACHINE.

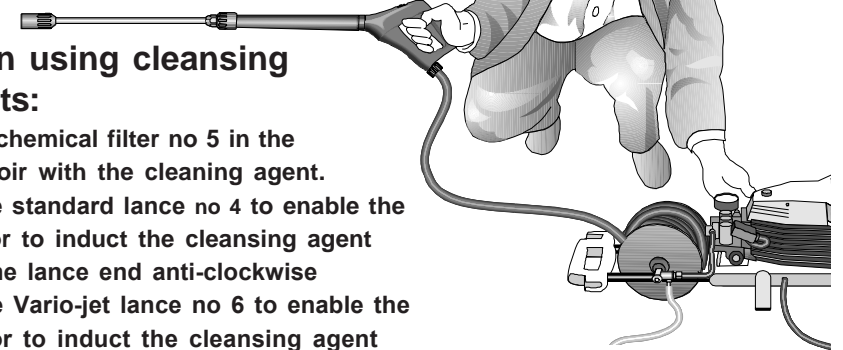

### When using cleansing agents:

Place chemical filter no 5 in the reservoir with the cleansing agent. On the standard lance no 4 to enable the injector to induct the cleansing agent turn the lance end anti-clockwise. On the Vario-jet lance no 6 to enable the injector to induct the cleansing agent Push to the forward position

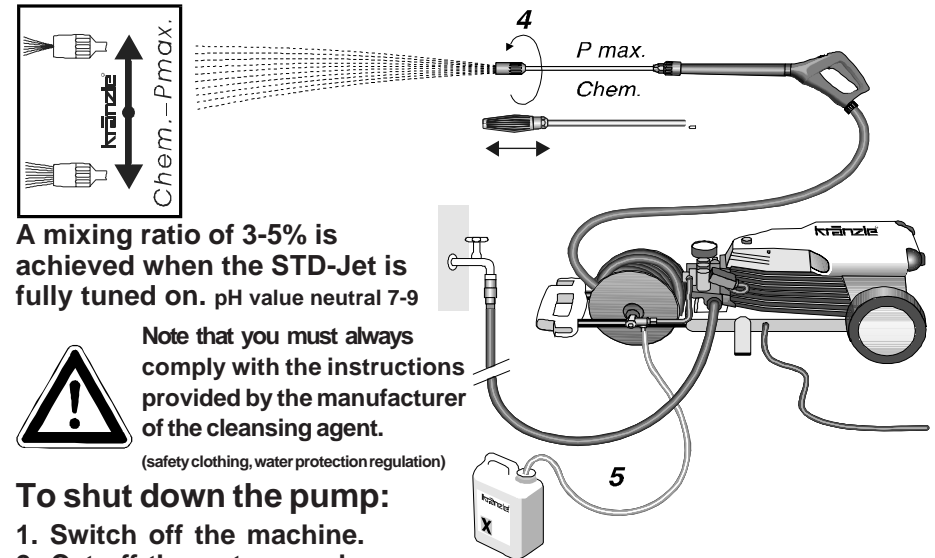

A mixing ratio of 3-5% is achieved when the STD-Jet is fully tuned on. pH value neutral 7-9



Note that you must always comply with the instructions provided by the manufacturer of the cleansing agent.

(safety clothing, water protection regulation)

### To shut down the pump:

1. Switch off the machine.
2. Cut off the water supply.
3. Open the spray gun briefly until the pressure is released.
4. Apply the safety catch on the spray gun.
5. Remove the water hose and spray gun.
6. Drain the pump: swith on the motor for appox 20 seconds.
7. Pull the plug from the socket.
8. Winter: store the pump in rooms above 0°C.
9. Clean the water filter.